

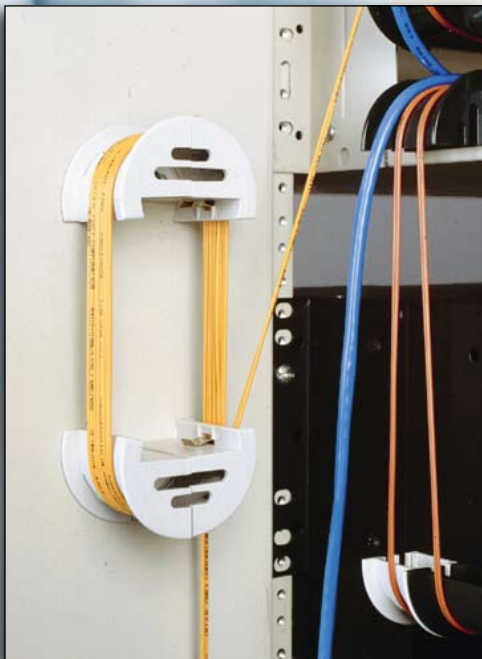

Patch Panel Egress



Service Loop/Take-up Reel

Faster Fiber Management Solutions

Do your fiber optics need rounding up? Sharp corners may be fun on the racetrack, but they can wreak havoc on your fiber optic cables, causing lost data and reduced efficiency.

Fast-Drop Fiber Bend Radius Control Modules provide the BICSI recommended minimum bend radius for fiber optic cables, assuring consistent data transmission. The Fast-Drop is molded of UL94 V-0 flame retardant, impact resistant polycarbonate and is rigid enough to withstand large bundle loads. NEBS compliant.

The universal Fast-Drop quickly snaps on to any panel edge up to 0.104" (2.7mm), retained by a RoHS compliant plated steel slip. It also may be screw or tab mounted to the cabinet to make service loops.

Cables are easily contained with the use of our hook and loop strap. Available from stock in three containment widths: 1" (2.5cm), 1.75" (4.4cm), and 3" (7.6cm), in black or beige.

Slotted side design allows for easy screw and/or stacking attachment

Features and Benefits:

- Protects cables from kinks
- Service loops mounting
- Fits within standard unit racks
- Snaps into place
- Impact resistant
- Hook and loop strap containment option
- Flame retardant per UL94 V-0
- RoHS compliant
- Three sizes, two colors
- Available from stock

Applications:

- FTTH or FTTP cabling
- Patch panels, control boxes, racks, cabinets, and enclosures
- Data centers/central offices
- Telecom switches and base stations
- Medical, x-ray, and imaging equipment
- Industrial equipment

Uses:

- Fiber and copper cables
- Electrical wiring
- Pneumatic and fluid tubing
- Hydraulic hoses

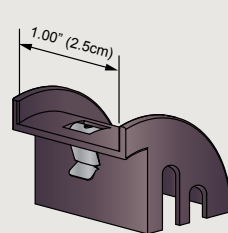

321-1

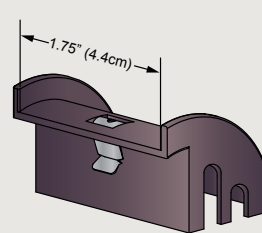

321-2

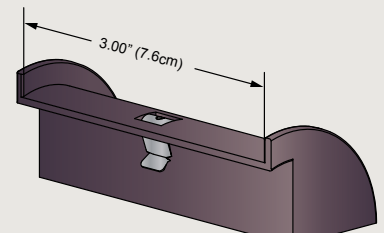

321-3

Fast-Drop Specifications and Ordering Options

Specifications:

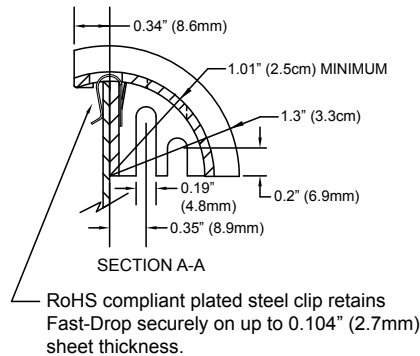
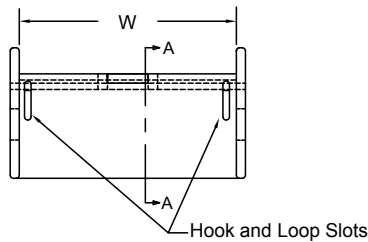

Material: Polycarbonate
Flammability: UL94 V-0
Color: Black or Beige
Typical Wall Thickness: 0.090" (2.3mm)

Mounting Options:

Side Screw Mounting

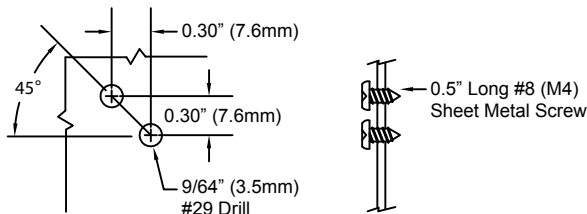

Drill one hole per drill pattern above. Insert first screw and mount Fast-Drop. Use Open slot to spot and drill the second hole and insert second screw.

Vertical Tab Mounting

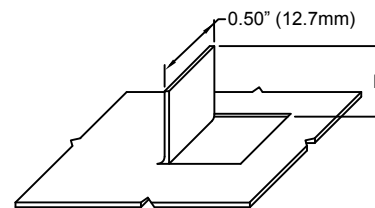

P/N	H
321-1	0.94" (2.4mm)
321-2	1.34" (3.4mm)
321-3	1.94" (4.9mm)

Optional: Include slot tab to lock clip in place.

Part Numbers and Sizes:

Part #	Color	W Max Bundle Width		Overall Width	
		Inches	cm	Inches	cm
321-1A	Black	1.00	2.5	1.18	2.96
321-1B	Beige				
321-2A	Black	1.75	4.4	1.93	4.86
321-2B	Beige				
321-3A*	Black	3.00	7.6	3.18	8.06
321-3B*	Beige				

For Hook and Loop Straps add -HL to part number suffix (i.e. 321-1A-HL)

*3.00" Fast-Drop has no screw mounting slots

I.S. EN ISO 9001:2008 • AS9100-B/ISO 9001:2008 Certified. Registration No. AS19.4480
 Certified Vendor to Fortune 100 & 500 OEMs, JIT w/ MAJOR OEMs Worldwide, supported by International Distribution



www.devicetech.com

USA Toll Free: +1-800-669-9682
 Phone: +1-508-229-2000 x 130
 Fax: +1-508-229-2622
 Email: customerservice@devicetech.com



The information contained in this data sheet is based on our experience to date and is believed to be reliable. It is intended as a guide for use by persons having technical skill at their discretion and risk. We do not guarantee favorable results or assume any liability in connection with its use. Dimensions contained herein are for reference purposes only. For specific dimensional requirements, consult the factory. This publication is not to be taken as license to operate under, or a recommendation to infringe upon any existing patents. This supersedes and voids all previous literature, etc. Device Technologies, Inc. expressly disclaims any and all express or implied warranties concerning its products including without limitation, warranty of fitness for a particular purpose and warranty of merchantability.